

# Standard Disposables Design™

## FILTER SETS

### 10" Filters

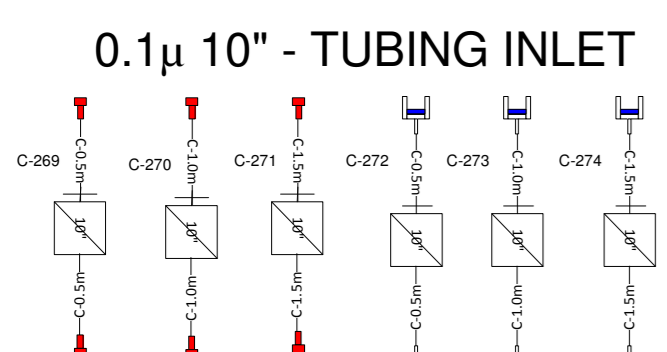
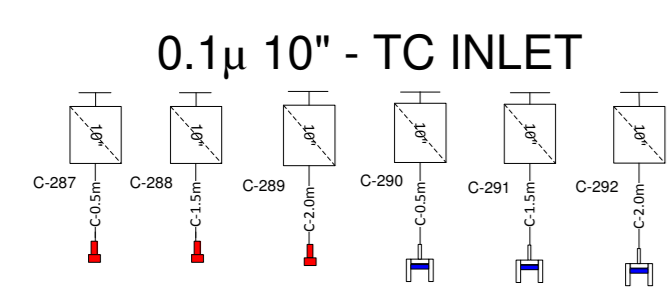
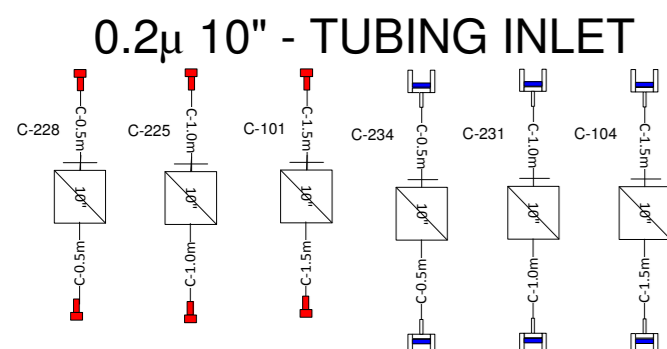
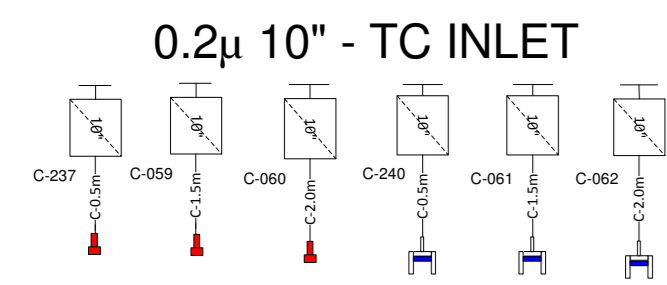

### 5" Filters

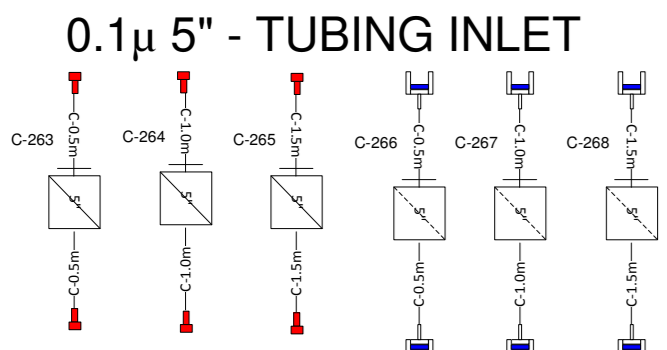
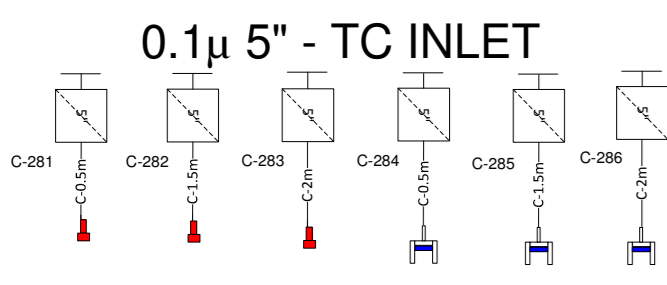
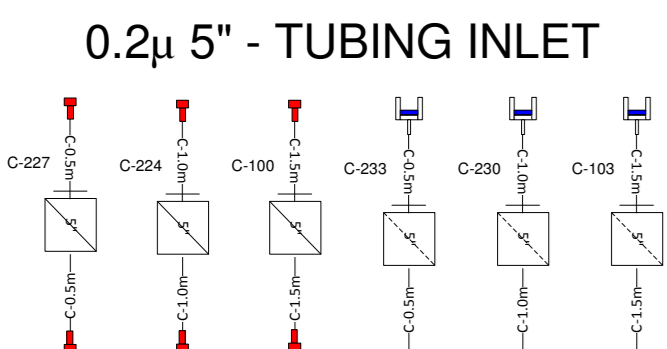
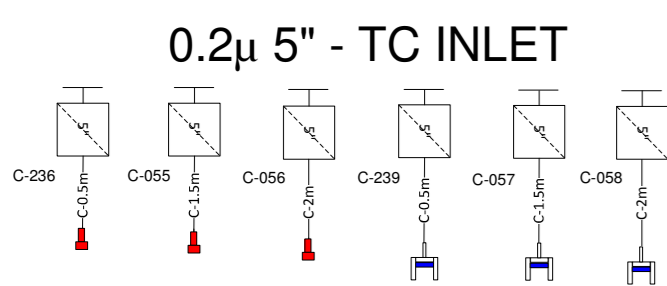

### 2" Filters

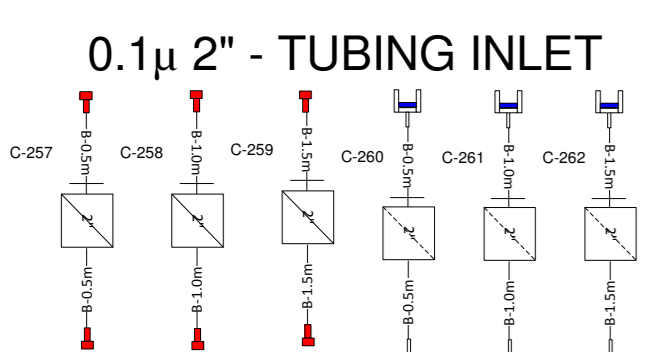
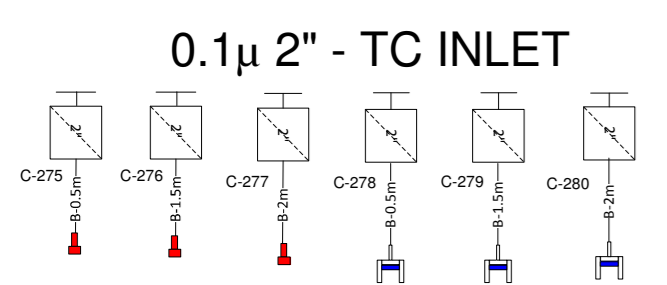
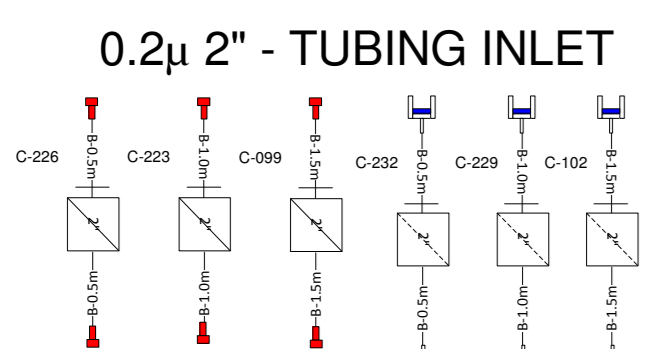
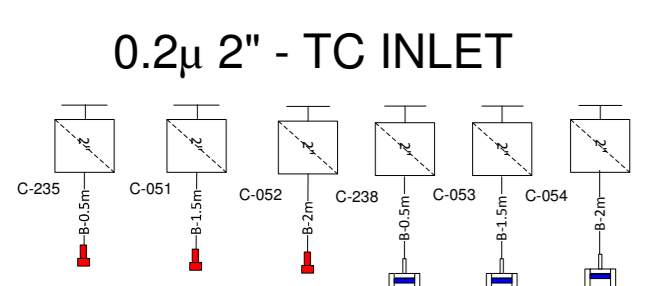

## 2D BAGS

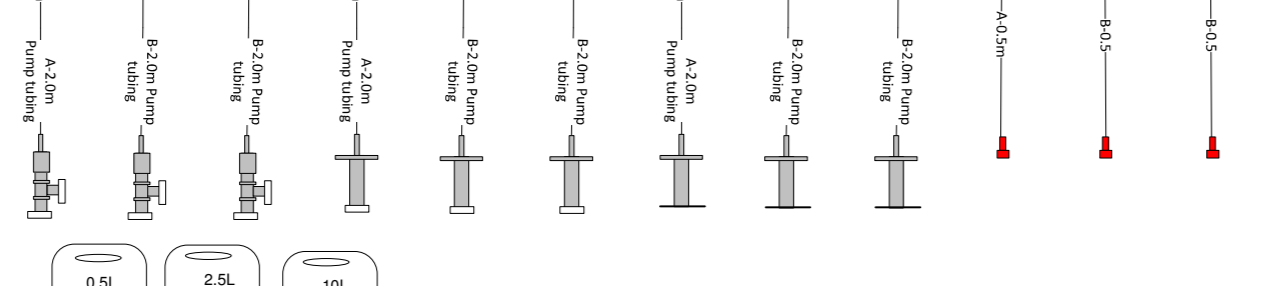
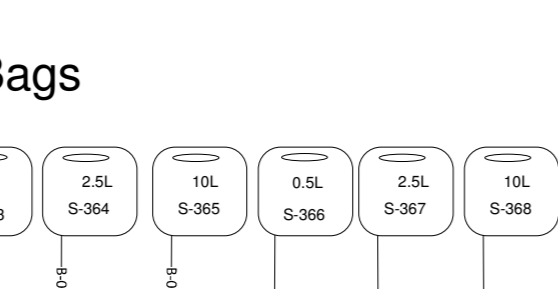
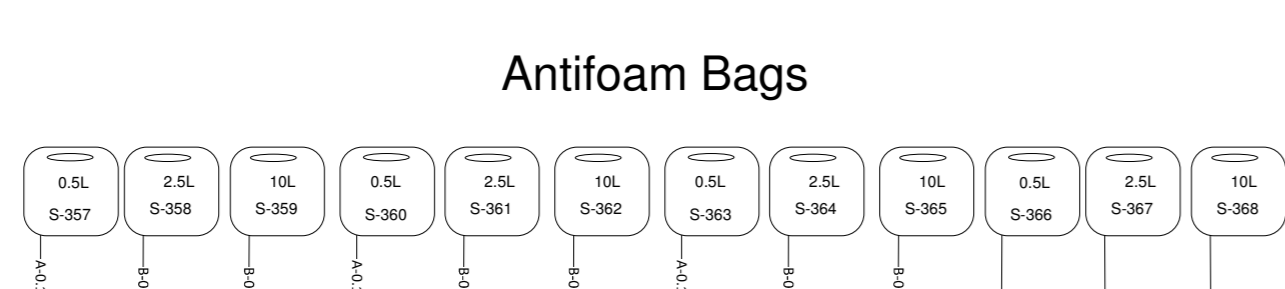
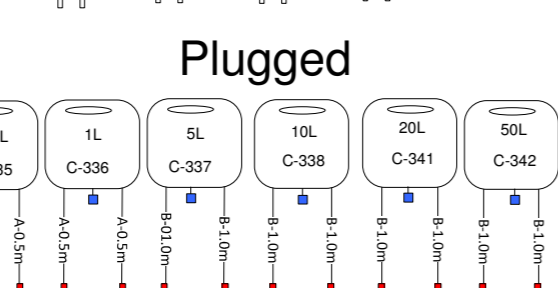
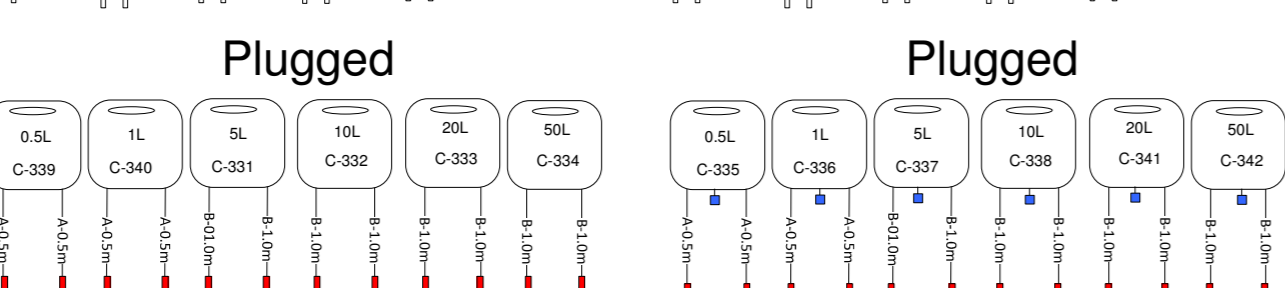
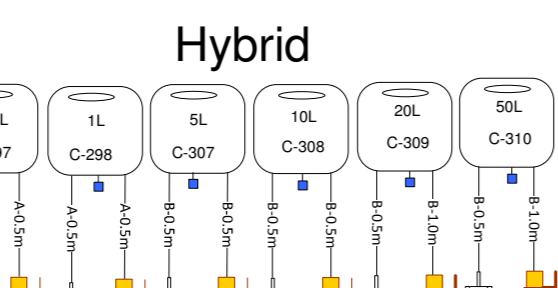
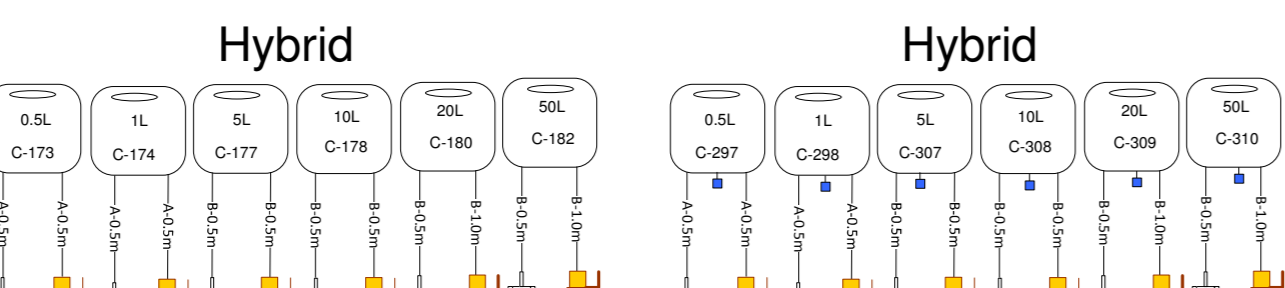
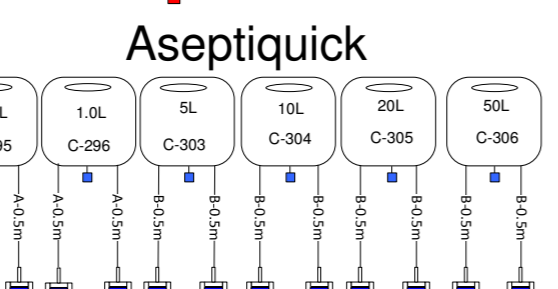
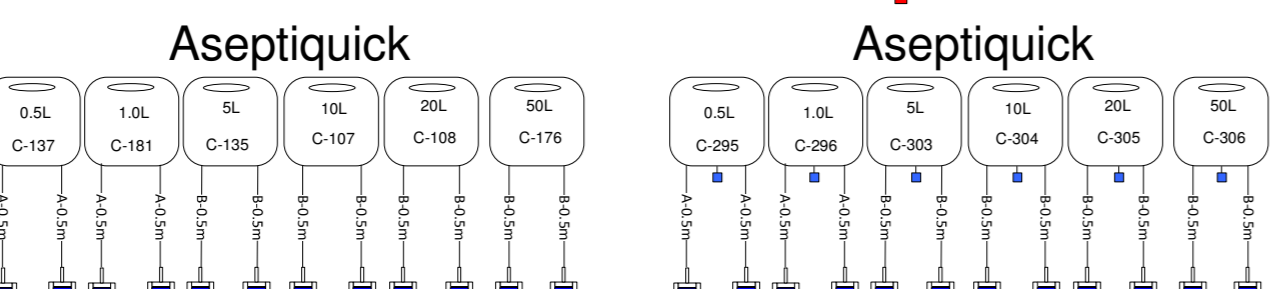
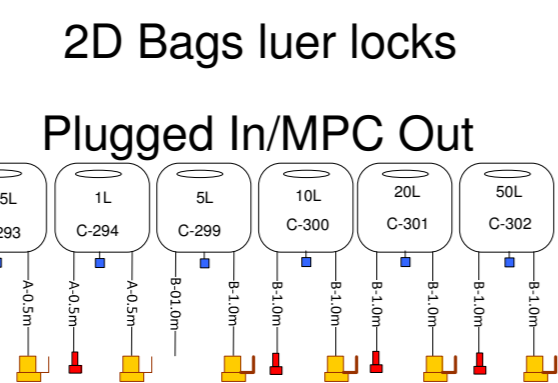
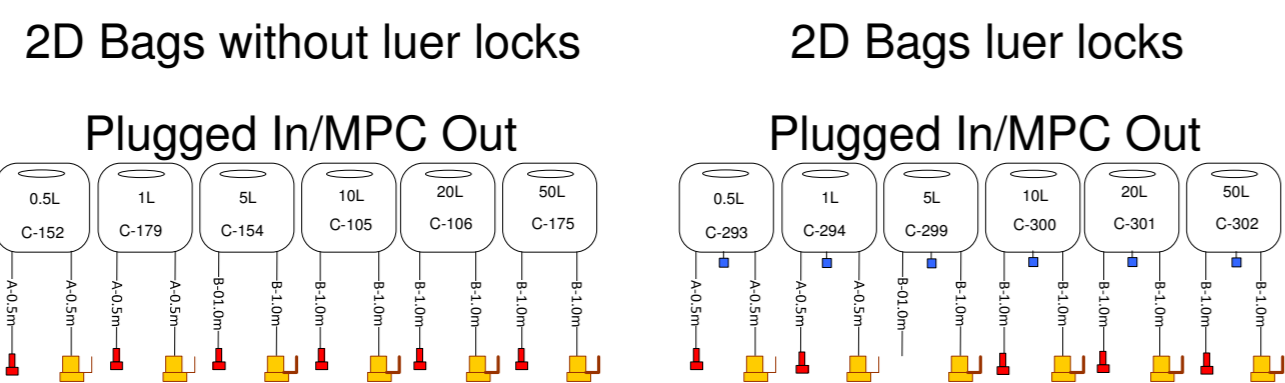
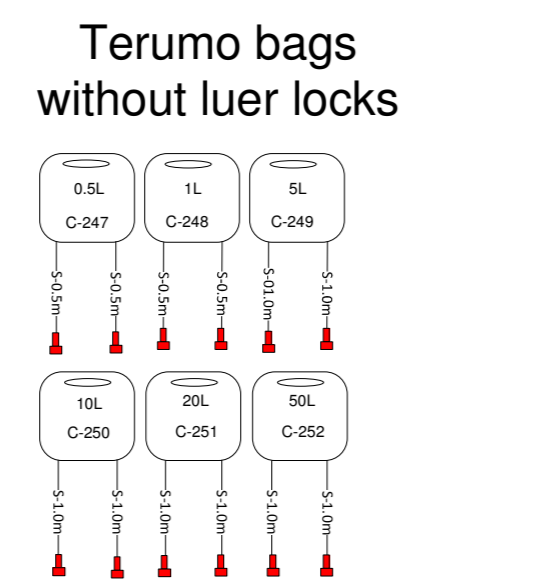
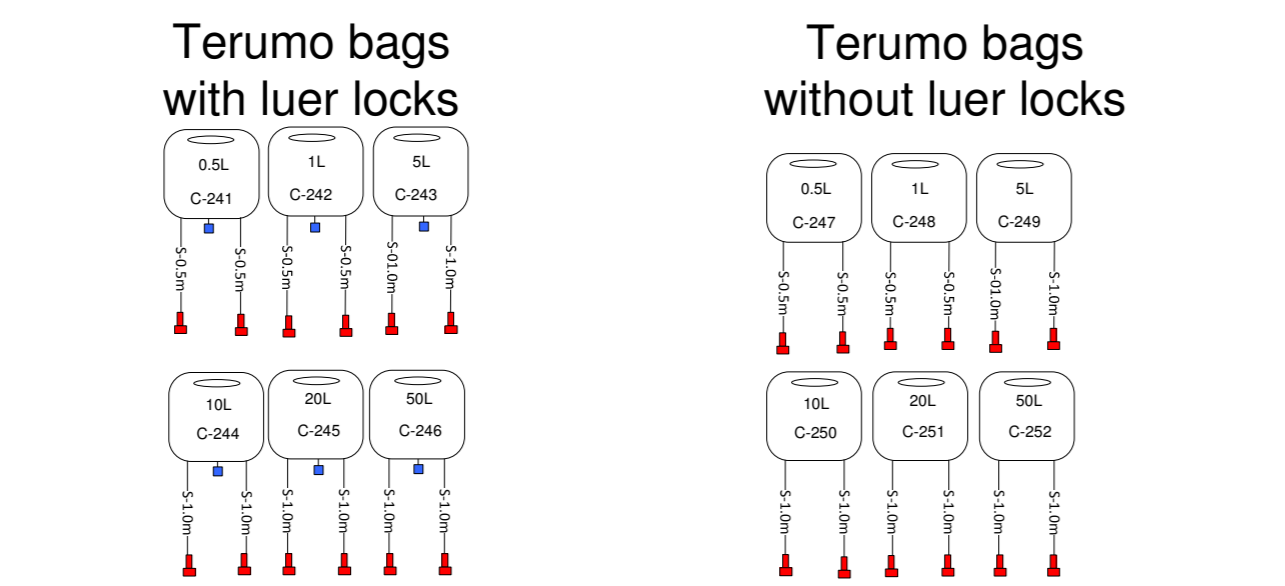

## 3D BAGS

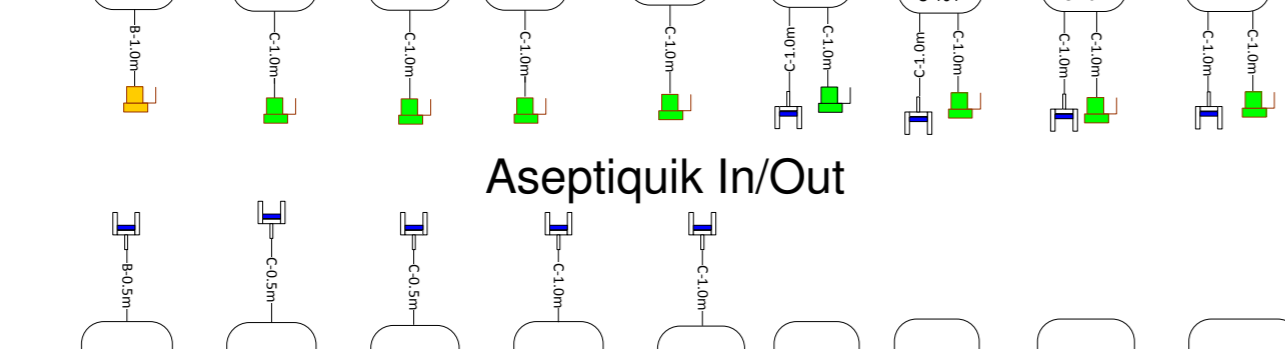
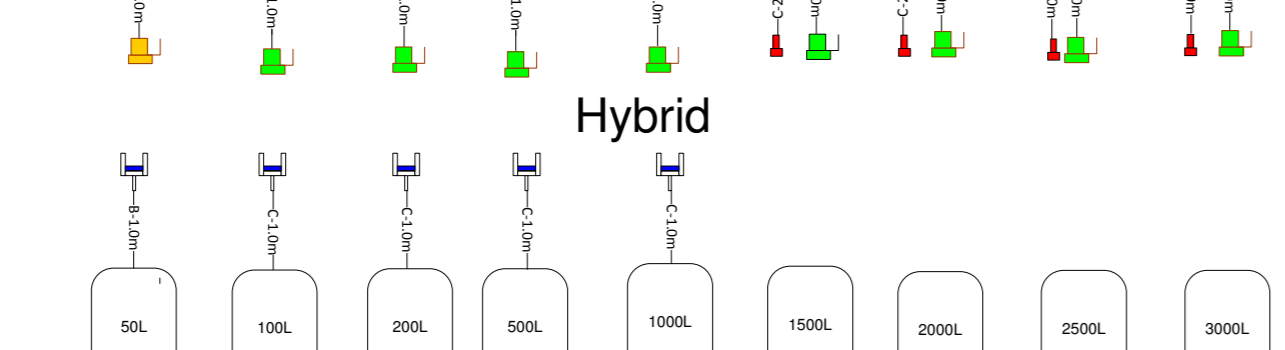
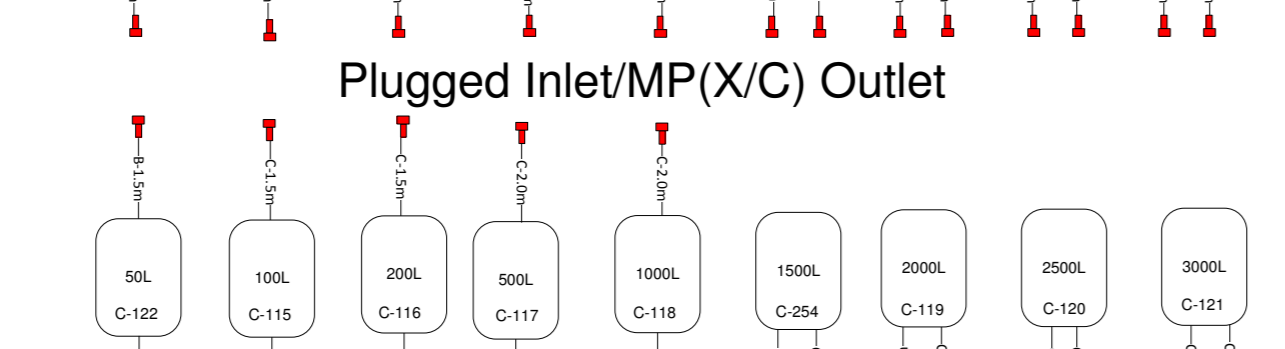
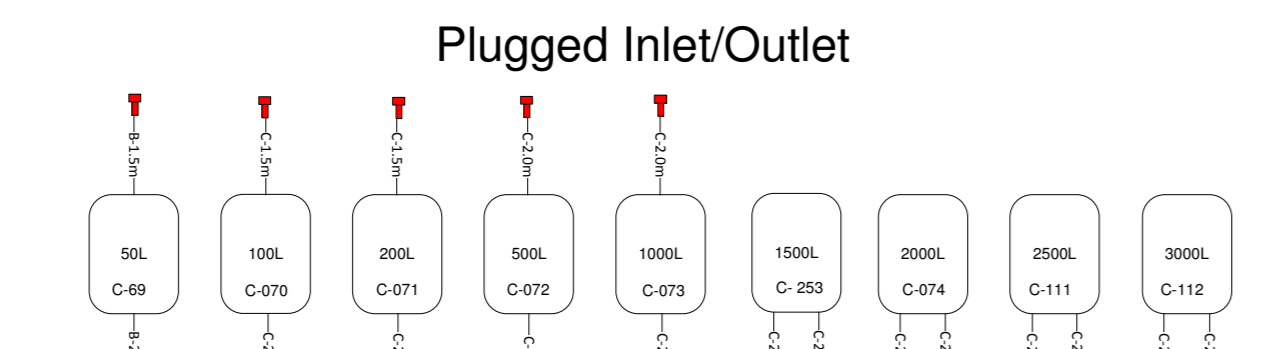

## TUBING

### MPC/MPX With Triclamp 3/4" or 1/2"

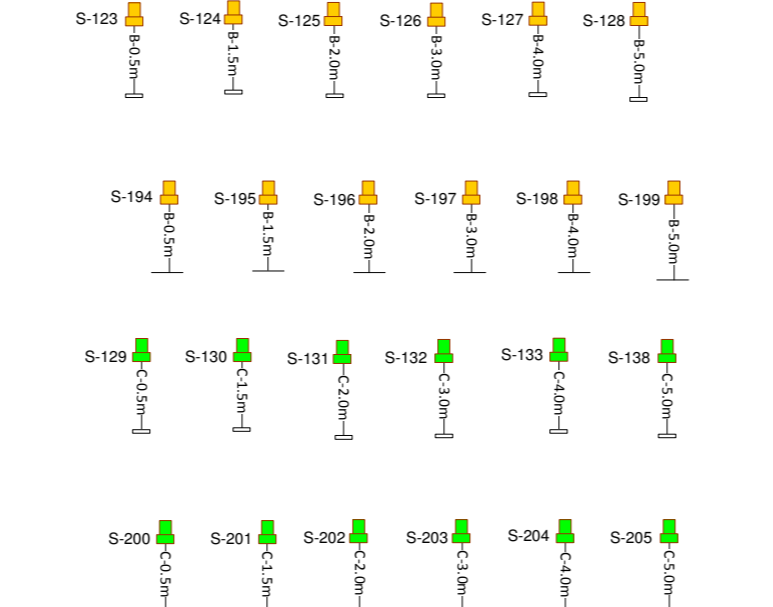

### Welding Manifolds

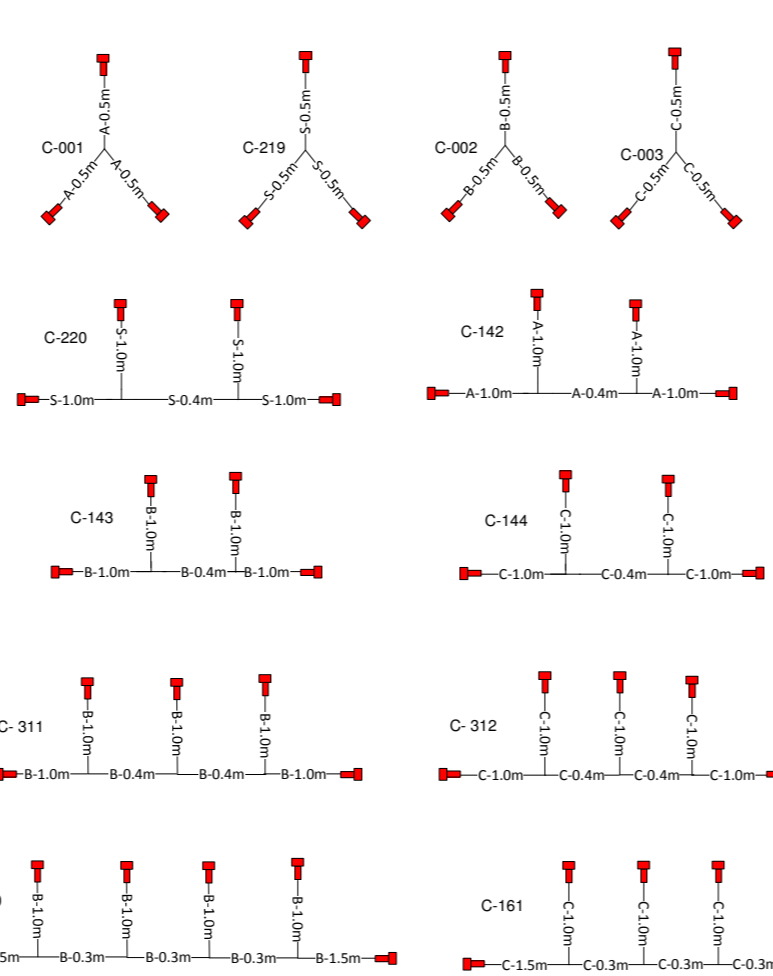

### EXTENSION SETS

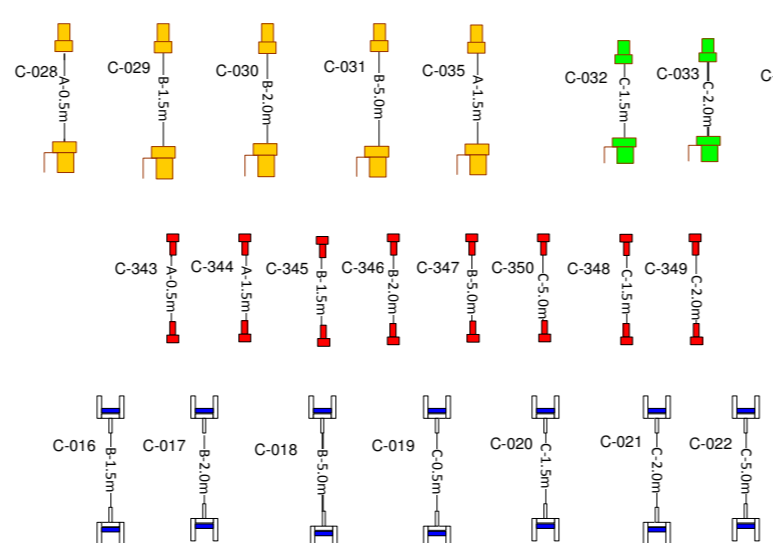

### ASEPTIQUIK MANIFOLDS

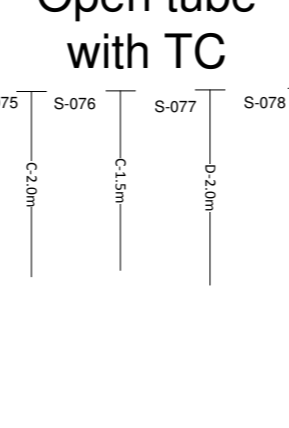
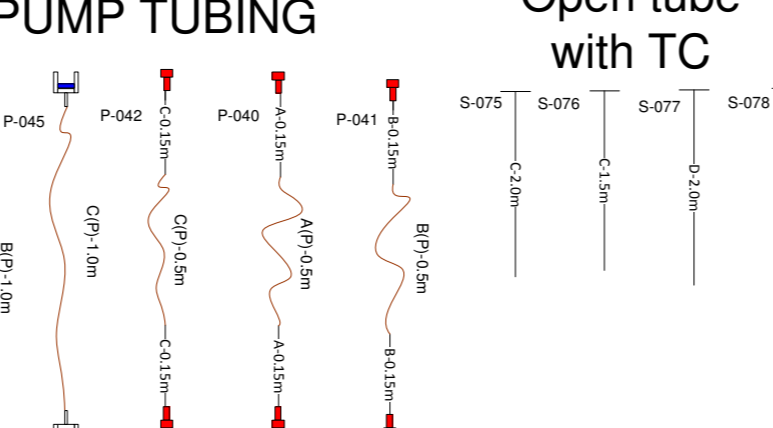
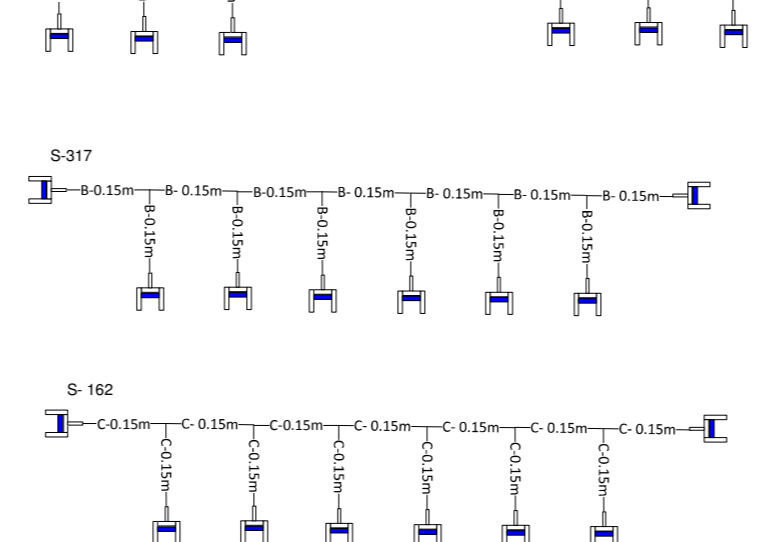
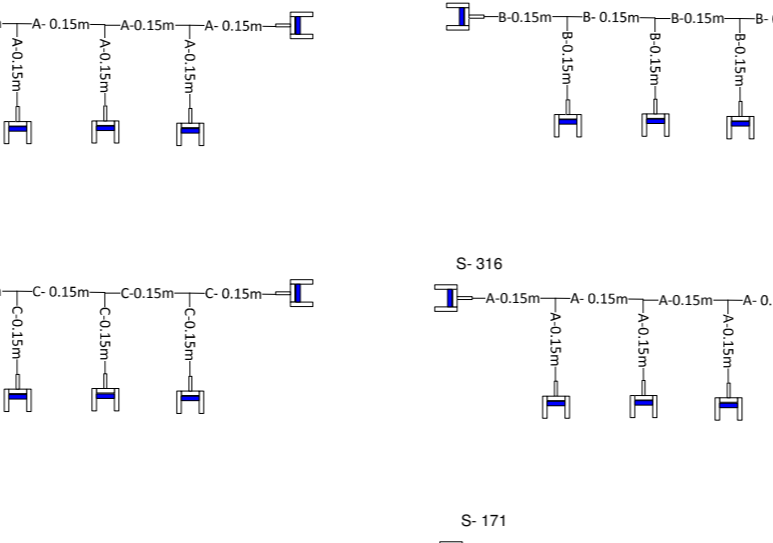
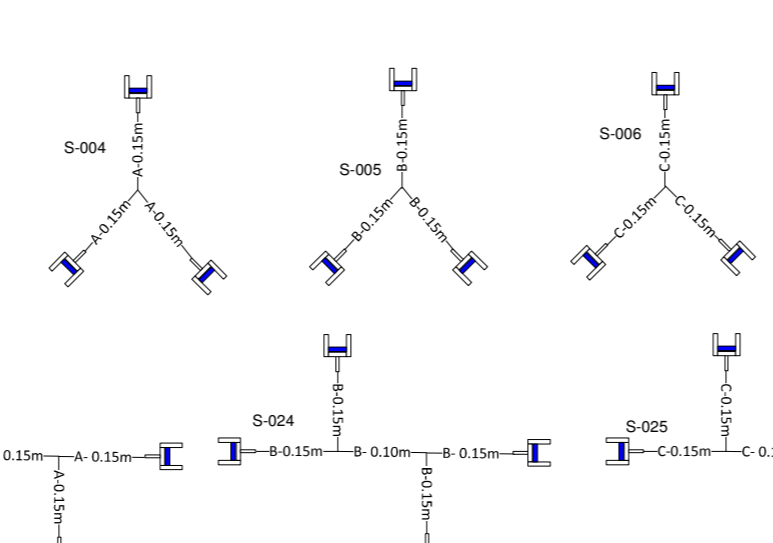

## BAG MANIFOLDS

### ASEPTIQUIK 2D BAG & HYBRID MANIFOLDS

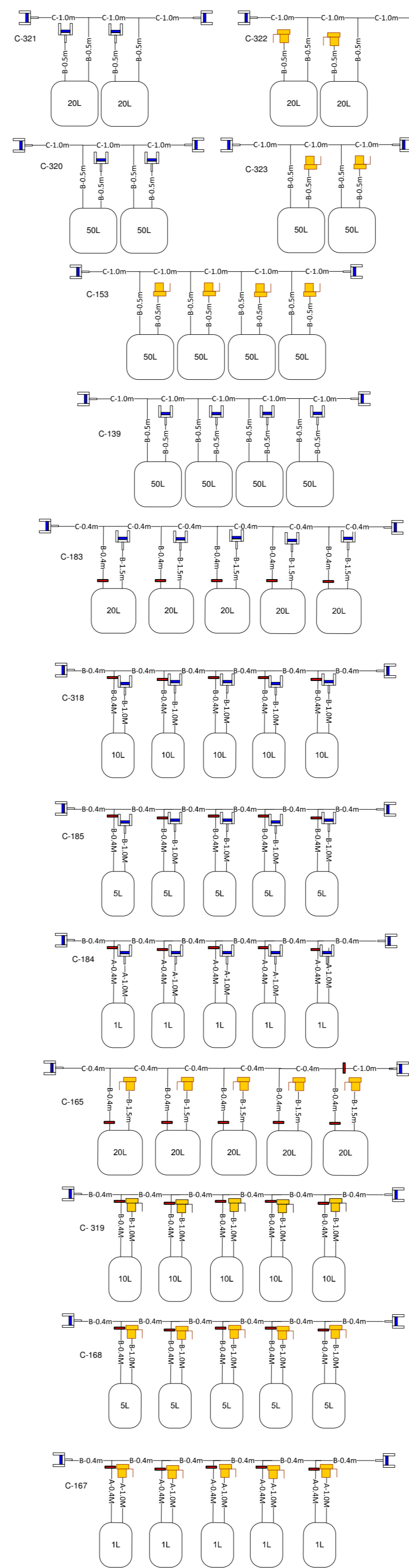

### 2D BAG WELDED BAG MANIFOLDS

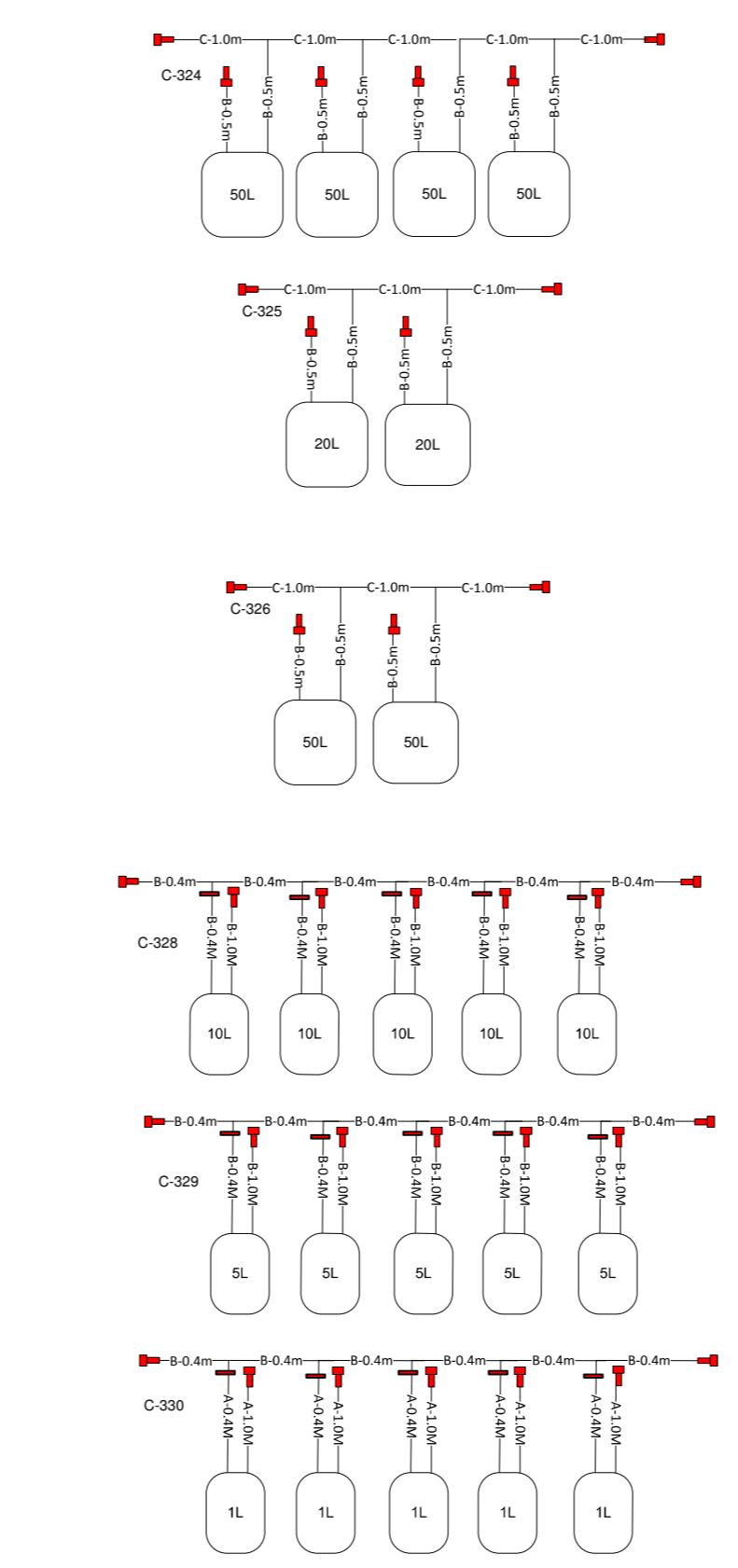

## MIXERS

### Mix bag with TC Outlet

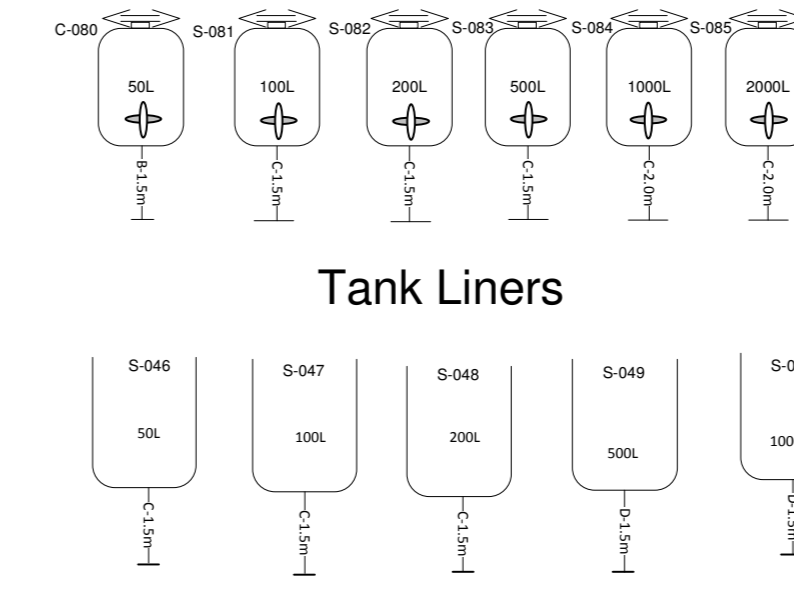

### Tank Liners

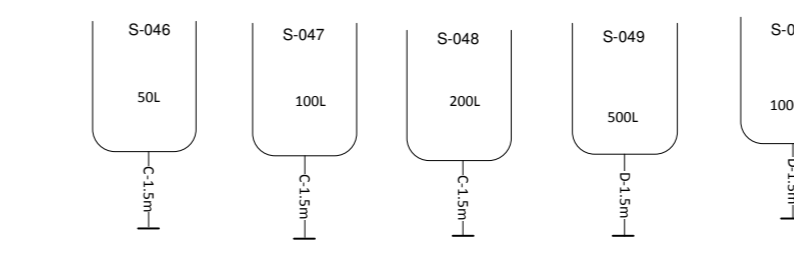

### Mix bag - ASEPTIQUIK In/out

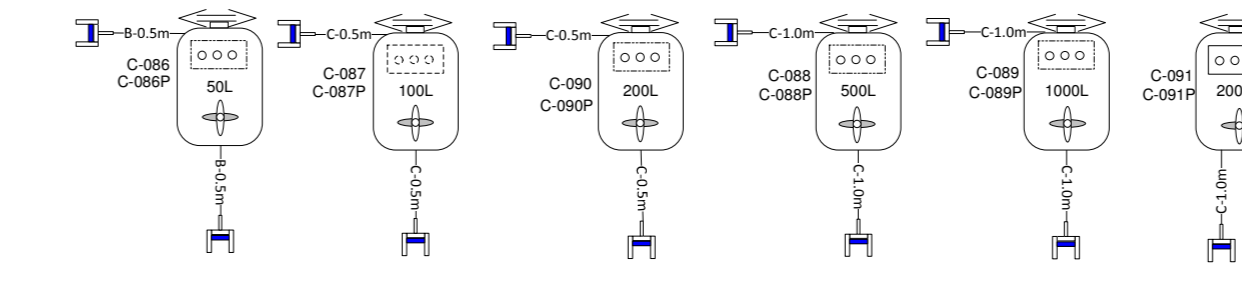

### Hybrid mix bag

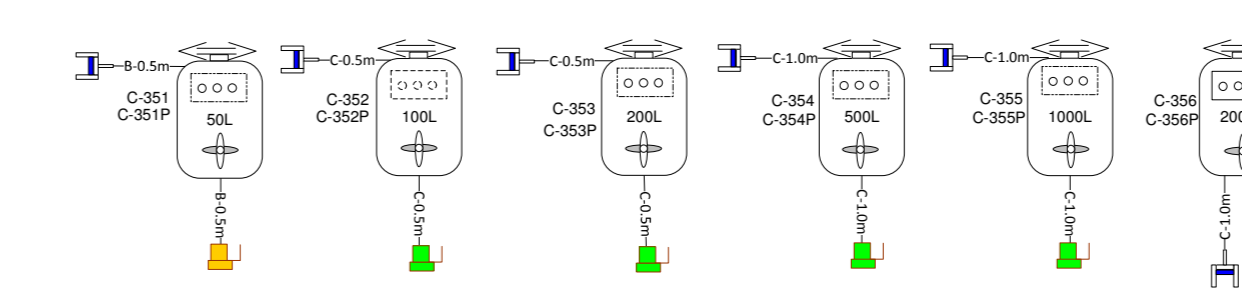

### Mix bag for welder

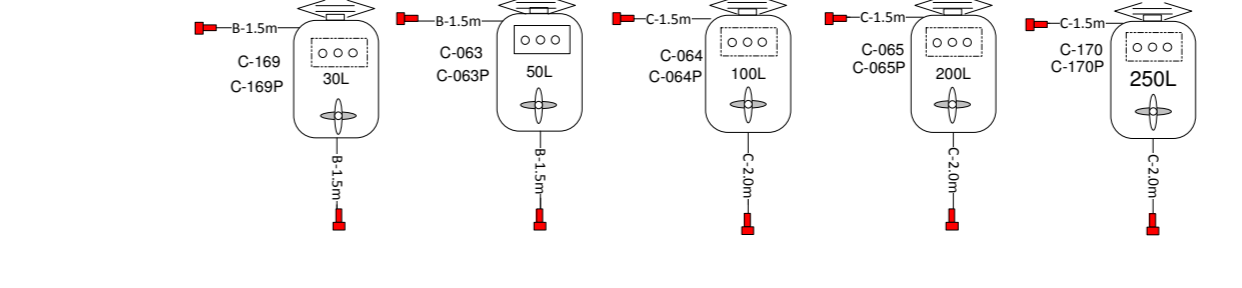

## STEAM-ON SETS

### LYNX STEAM-ON SETS

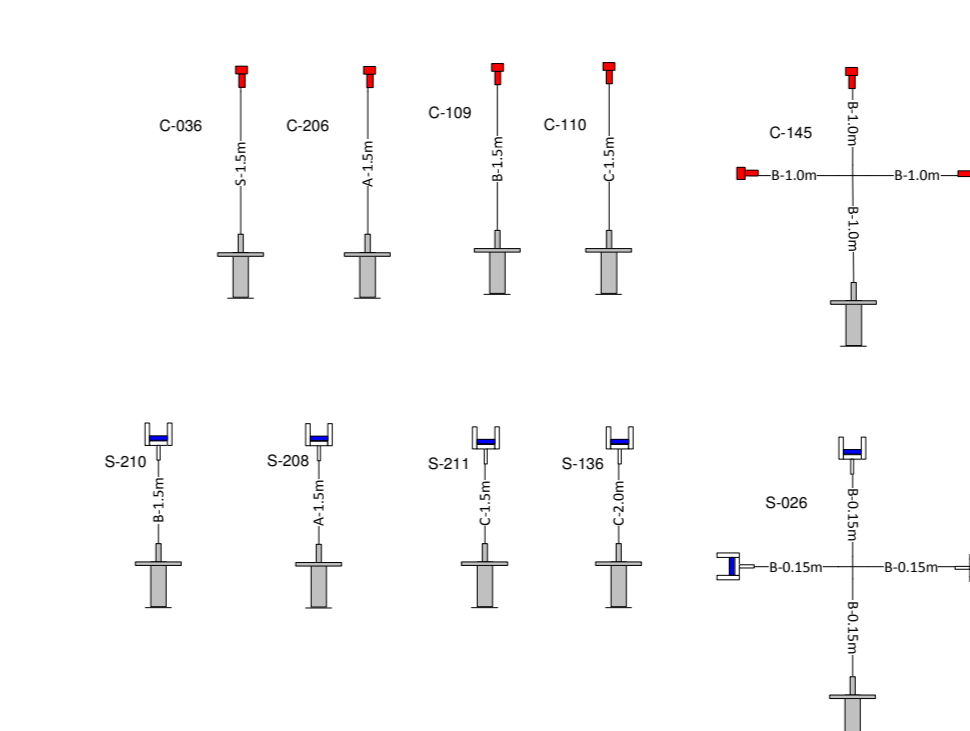

### COLDER STEAM-ON SETS

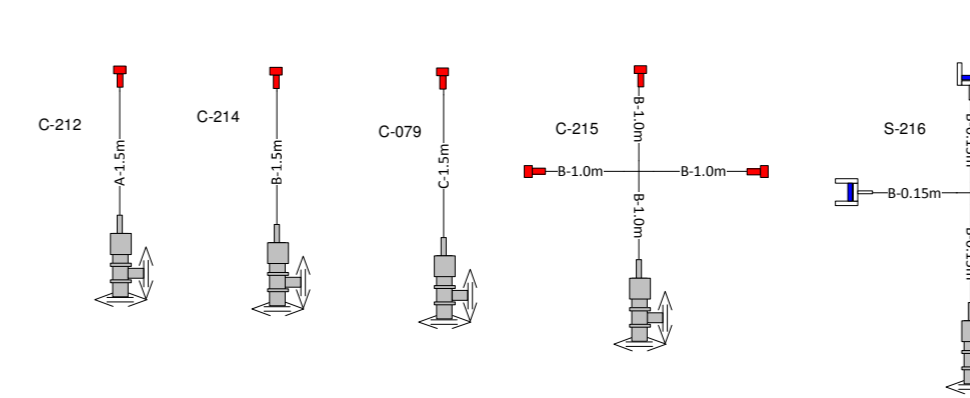

## SAMPLING SETS

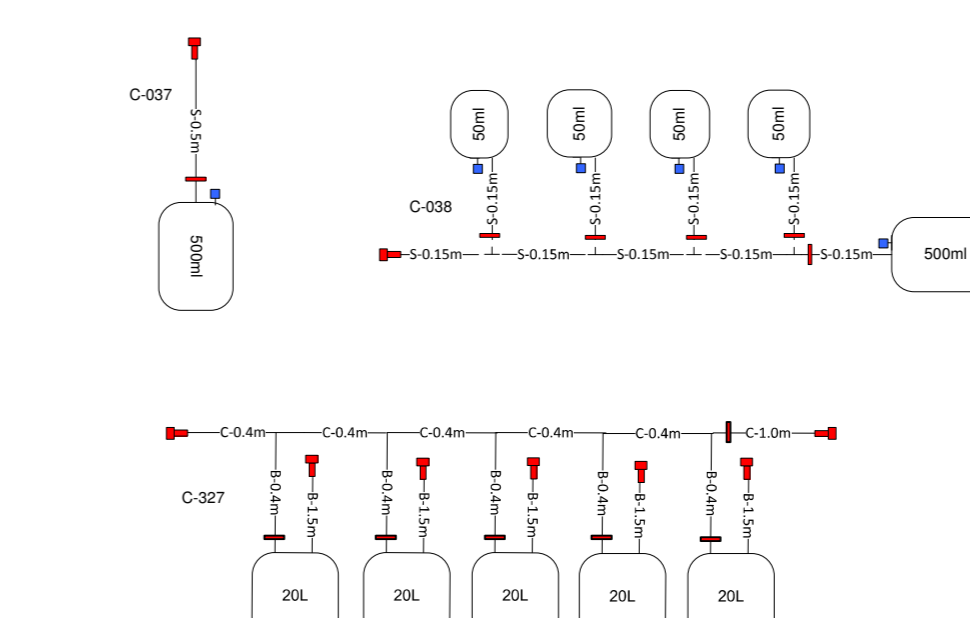

Nominal Tubing Sizes  
The Tubing size listed here is nominal  
If C-flex is used then it needs to be C-Flex  
374a.

Tubing Codes		
	ID	OD
S	1/8"	3/8"
A	1/4"	3/8"
B	3/8"	5/8"
C	1/2"	3/4"
D	3/4"	1"

PART SYMBOLS	
1 1/2" TRICLAMP	—
3/4" TRICLAMP	□
ASEPTIQUIK	⊞
MPC	⊞
MPX	⊞
PLUGGED	⊞

**Aseptic Connector Note**  
It has been agreed that if a supplier insists on their own aseptic connector they can replace the Aseptiquik with that connector as long as the SDD part code has a sub code indicating this change.